









S-S69C Installation Guide









CONTENTS ■CONTENU

Woofers

- ①  × 2
- ② $\phi 4 \times 30\text{mm}$  × 8
- ③  × 8
- ④ $M4 \times 60\text{mm}$  × 8
- ⑤  × 16
- ⑥  × 8
- ⑦  × 8
- ⑧  × 8

- ⑨  × 2

Tweeter

- ⑩  × 2
- ⑪  × 2
- ⑫  × 2
- ⑬  × 2
- ⑭  × 2
- ⑮  × 2
- ⑯  × 2
- ⑰  × 2

Network

- ⑱  × 2

WOOFER INSTALLATION ■INSTALLATION DU WOOFER

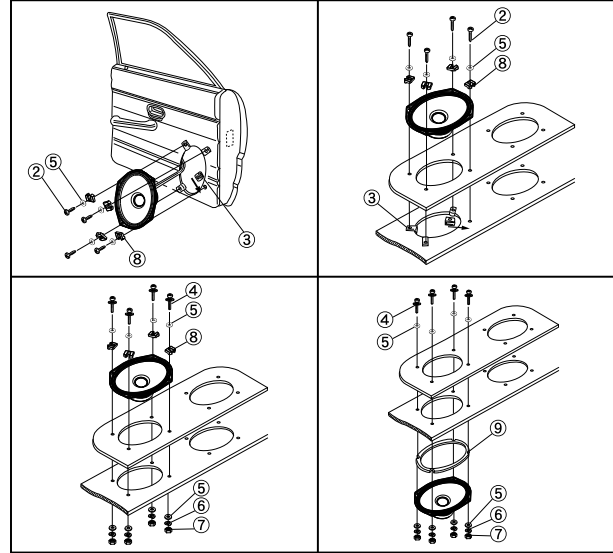

WIRING CONNECTION ■CONNEXIONS DE CÂBLAGE

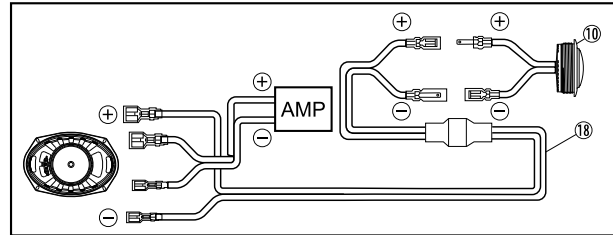

EXTERNAL DIMENSIONS ■DIMENSIONS EXTERNES

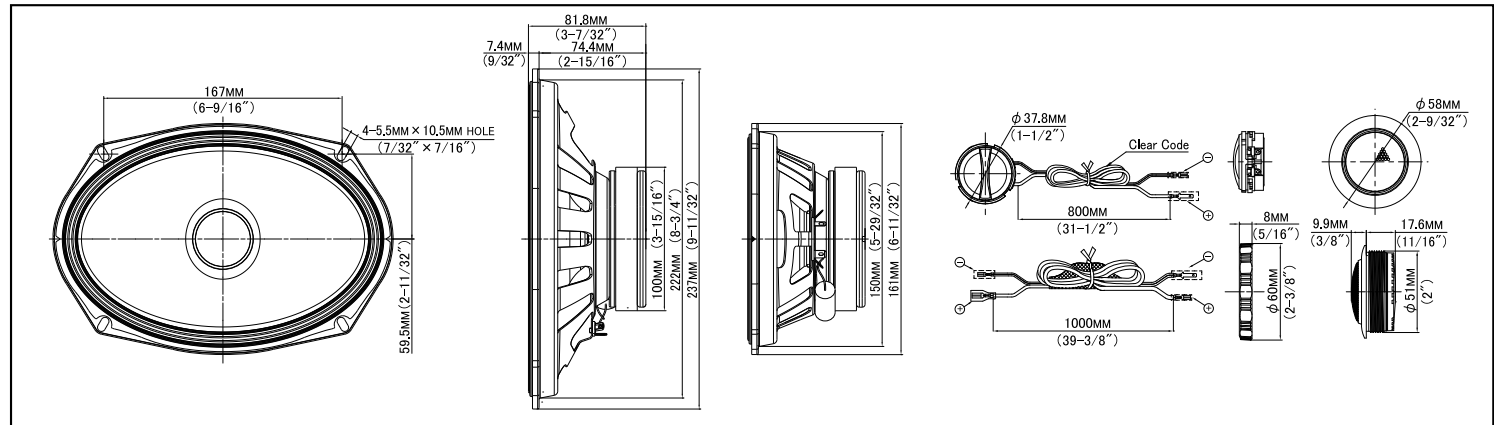

TWEETER INSTALLATION ■INSTALLATION DU TWEETER

Swivel flush mount
Montage rotatif en affleurement

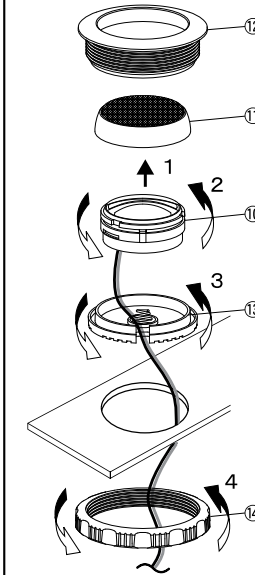

Stealth (May require gluing)
Montage caché (un collage peut être nécessaire)

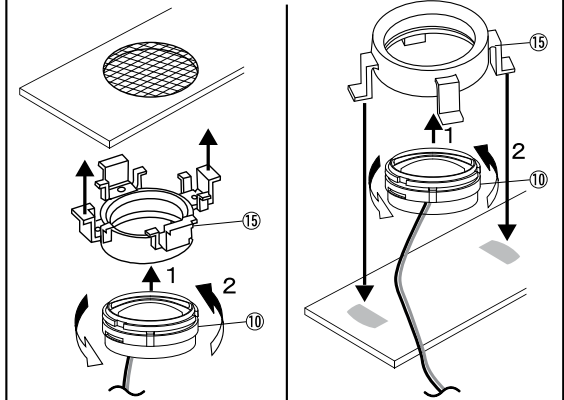

Height adjustment

Ajustement de la hauteur

